

(Axial Fan)

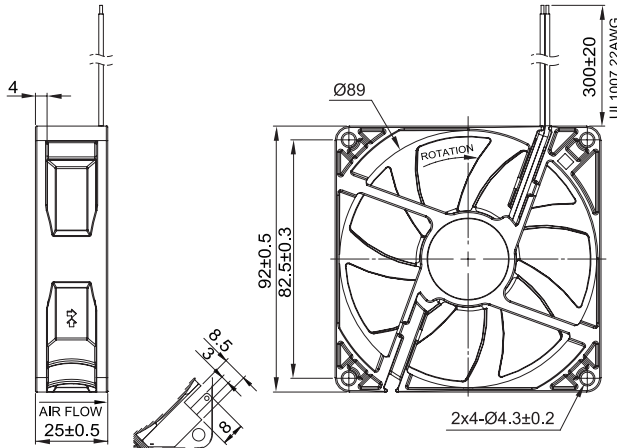

Electronically-Protected

Terminal or Lead Wire Type

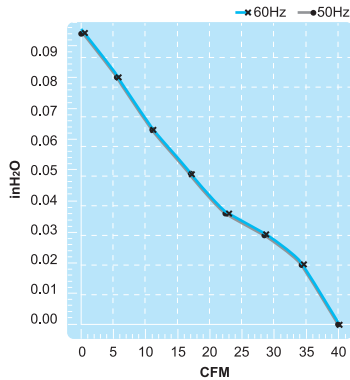

Spec.	Rated Voltage	Frequency	Input Power	Rated Current	Locked Current	Speed	Maximum Air Flow	Maximum Air Flow	Maximum Pressure	Maximum Pressure	Noise	Weight
Model	V	Hz	W	A	A	RPM	m ³ /min.	CFM	mmH ₂ O	InchH ₂ O	dB	kg
UFT92BBPB0AM1D4A	115~230	50/60	3.0	0.06 (115V) 0.04 (230V)	0.082 (115V) 0.038 (230V)	2650	1.1	39	2.3	0.09	34	0.085