

UF12A Series

Size : 120 x 120 x 38
Unit : mm

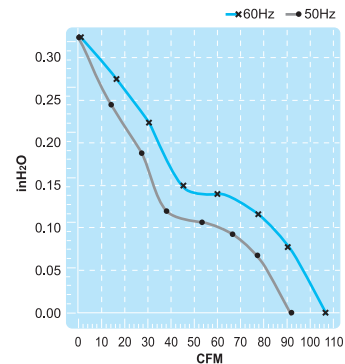
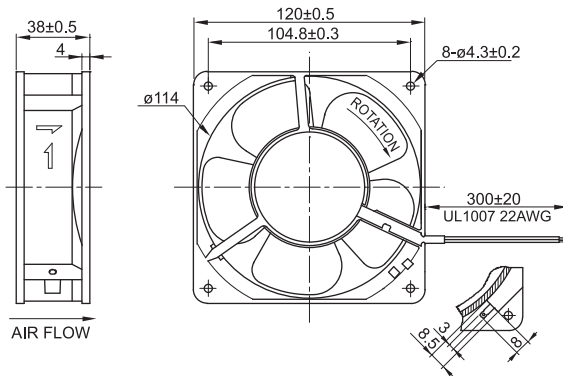

Impedance Protection

Terminal or Lead Wire Type



Spec. Model	Rated Voltage V	Frequency Hz	Input Power W	Rated Current A	Locked Current A	Speed RPM	Maximum Air Flow m ³ /min.	Maximum Air Flow CFM	Maximum Pressure mmH ₂ O	Maximum Pressure InchH ₂ O	Noise dB	Weight kg
UF12A10-H	100V	50	19	0.24	0.33	2700	2.6	92	8.0	0.32	42	0.53
		60	16	0.20	0.27	3100	3.0	106	8.0	0.32	46	
UF12A11-H	115V	50	14	0.20	0.27	2700	2.6	92	8.0	0.32	42	0.53
		60	12	0.16	0.23	3100	3.0	106	8.0	0.32	46	
UF12A20-H	200V	50	19	0.12	0.17	2700	2.6	92	8.0	0.32	42	0.53
		60	16	0.10	0.13	3100	3.0	106	8.0	0.32	46	
UF12A23-H	230V	50	17	0.10	0.14	2700	2.6	92	8.0	0.32	42	0.53
		60	15	0.08	0.12	3100	3.0	106	8.0	0.32	46	
UF12A11-M	115V	50	14	0.18	0.20	2500	2.4	85	6.5	0.26	40	0.53
		60	12	0.17	0.19	2750	2.6	92	7.0	0.28	42	
UF12A23-M	230V	50	17	0.09	0.10	2500	2.4	85	6.5	0.26	40	0.53
		60	15	0.08	0.09	2750	2.6	92	5.5	0.22	42	
UF12A11-L	115V	50	14	0.16	0.18	2100	2.1	75	4.0	0.16	36	0.53
		60	12	0.15	0.16	2300	2.3	82	4.1	0.16	38	
UF12A23-L	230V	50	17	0.08	0.09	2100	2.1	75	4.0	0.16	36	0.53
		60	15	0.07	0.08	2300	2.3	82	4.1	0.16	38	